

12-29-99

UTILITY PATENT APPLICATION TRANSMITTAL (Large Entity)

(Only for new nonprovisional applications under 37 CFR 1.53(b))

Docket No.
66180.0400/HW A62-25527 US

Total Pages in this Submission: 16

TO THE ASSISTANT COMMISSIONER FOR PATENTS

Box Patent Application
Washington, D.C. 20231

Submitted herewith for filing under 35 U.S.C. 111(a) and 37 C.F.R. 1.53(b) is a new utility patent application for an invention entitled:

PARTITIONED FLAT FLUORESCENT LAMP

and invented by:

ALAN S. FELDMAN

If a **CONTINUATION APPLICATION**, check appropriate box and supply the requisite information:

Continuation Divisional Continuation-in-part (CIP) of prior application No.: _____

Which is a:

Continuation Divisional Continuation-in-part (CIP) of prior application No.: _____

Which is a:

Continuation Divisional Continuation-in-part (CIP) of prior application No.: _____

Enclosed are:

Application Elements

1. Filing fee as calculated and transmitted as described below
2. Specification having 17 pages and including the following:
 - a. Descriptive Title of the Invention
 - b. Cross References to Related Applications (if applicable)
 - c. Statement Regarding Federally-sponsored Research/Development (if applicable)
 - d. Reference to Microfiche Appendix (if applicable)
 - e. Background of the Invention
 - f. Brief Summary of the Invention
 - g. Brief Description of the Drawings (if drawings filed)
 - h. Detailed Description
 - i. Claim(s) as Classified Below
 - j. Abstract of the Disclosure

12/28/99

12/28/99

**UTILITY PATENT APPLICATION TRANSMITTAL
(Large Entity)**

(Only for new nonprovisional applications under 37 CFR 1.53(b))

Docket No.
66180.0400/HW A62-25527-US

Total Pages in this Submission

Application Elements (Continued)

3. Drawing(s) *(when necessary as prescribed by 35 USC 113)*
- a. Formal Number of Sheets _____
- b. Informal Number of Sheets 14
4. Oath or Declaration
- a. Newly executed *(original or copy)* Unexecuted
- b. Copy from a prior application (37 CFR 1.63(d)) *(for continuation/divisional application only)*
- c. With Power of Attorney Without Power of Attorney
- d. DELETION OF INVENTOR(S)
Signed statement attached deleting inventor(s) named in the prior application,
see 37 C.F.R. 1.63(d)(2) and 1.33(b).
5. Incorporation By Reference *(usable if Box 4b is checked)*
The entire disclosure of the prior application, from which a copy of the oath or declaration is supplied
under Box 4b, is considered as being part of the disclosure of the accompanying application and is hereby
incorporated by reference therein.
6. Computer Program in Microfiche *(Appendix)*
7. Nucleotide and/or Amino Acid Sequence Submission *(if applicable, all must be included)*
- a. Paper Copy
- b. Computer Readable Copy *(identical to computer copy)*
- c. Statement Verifying Identical Paper and Computer Readable Copy

Accompanying Application Parts

8. Assignment Papers *(cover sheet & document(s))*
9. 37 CFR 3.73(B) Statement *(when there is an assignee)*
10. English Translation Document *(if applicable)*
11. Information Disclosure Statement/PTO-1449 Copies of IDS Citations
12. Preliminary Amendment
13. Acknowledgment postcard
14. Certificate of Mailing
- First Class Express Mail *(Specify Label No.):* EL426613718US

66180.0400

UTILITY PATENT APPLICATION TRANSMITTAL (Large Entity)

(Only for new nonprovisional applications under 37 CFR 1.53(b))

Docket No.
66180.0400/HW A62-25527-US

Total Pages in this Submission

Accompanying Application Parts (Continued)

15. Certified Copy of Priority Document(s) (if foreign priority is claimed)

16. Additional Enclosures (please identify below):

Fee Calculation and Transmittal

CLAIMS AS FILED

For	#Filed	#Allowed	#Extra	Rate	Fee
Total Claims	35	- 20 =	15	x \$18.00	\$270.00
Indep. Claims	3	- 3 =	0	x \$78.00	\$0.00
Multiple Dependent Claims (check if applicable) <input type="checkbox"/>					\$0.00
BASIC FEE					\$760.00
OTHER FEE (specify purpose) _____					\$0.00
TOTAL FILING FEE					\$1,030.00

- A check in the amount of _____ to cover the filing fee is enclosed.
- The Commissioner is hereby authorized to charge and credit Deposit Account No. _____ as described below. A duplicate copy of this sheet is enclosed.
- Charge the amount of _____ as filing fee.
 - Credit any overpayment.
 - Charge any additional filing fees required under 37 C.F.R. 1.16 and 1.17.
 - Charge the issue fee set in 37 C.F.R. 1.18 at the mailing of the Notice of Allowance, pursuant to 37 C.F.R. 1.311(b).

Signature

Dated: December 28, 1999

Deborah M. Chess, Reg. No. 44611, (602) 382-6388
Snell & Wilmer, L.L.P.
One Arizona Center, 400 E. Van Buren
Phoenix, Arizona 85004-2202
PLEASE DIRECT ALL CORRESPONDENCE TO:
Honeywell, Inc., Honeywell Plaza MN12-8251
Minneapolis, MN 55408

cc:

CERTIFICATE OF MAILING BY "EXPRESS MAIL" (37 CFR 1.10)

Applicant(s): **HONEYWELL, INC.**

Docket No.

66180.0400

Serial No.
TO BE ASSIGNED

Filing Date
December 28, 1999

Examiner

Group Art Unit

Invention: **PARTITIONED FLAT FLUORESCENT LAMP**

U.S. PTO
09/473176
12/28/99

I hereby certify that this Patent Application and accompanying paperwork

(Identify type of correspondence)

is being deposited with the United States Postal Service "Express Mail Post Office to Addressee" service under 37 CFR 1.10 in an envelope addressed to: The Assistant Commissioner for Patents, Washington, D.C. 20231

on December 28, 1999
(Date)

Deborah M. Chess

(Typed or Printed Name of Person Mailing Correspondence)

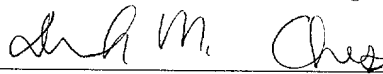

(Signature of Person Mailing Correspondence)

EL 426613718US

("Express Mail" Mailing Label Number)

Note: Each paper must have its own certificate of mailing.

EL426613718US

UNITED STATES PATENT APPLICATION

for a new and useful invention entitled

PARTITIONED FLAT FLUORESCENT LAMP

by Inventor:

Alan S. Feldman

Honeywell Docket No. A62-25527-US

Snell & Wilmer, L.L.P. Docket No. 66180.0400

66180.0400

PARTITIONED FLAT FLUORESCENT LAMP**Inventor: Alan S. Feldman**BACKGROUND OF THE INVENTION

5

1. Technical Field

The present invention generally relates to lighting systems, and more particularly, to fluorescent lamps.

2. Background

10 Many industries and applications need backlighting for an information source. In particular, transmissive liquid crystal displays (LCDs) have become very popular in many electronic media. LCDs are useful in applications such as avionics, laptop computers, video cameras, and automatic teller machines. However, many LCDs require backlighting to illuminate the information being displayed.

15 Various systems perform the backlighting function in conventional displays. For example, one way to backlight an information source employs an array of conventional straight tubular fluorescent lamps. Low costs associated with such conventional lamps control costs, but they are sometimes inadequate for particular applications. For instance, in avionics applications, the poor color quality of the phosphors and the short lamp life of conventional lamps, among other shortcomings, limit their usefulness.

20 To avoid the various problems with conventional lamps, many manufacturers employ customized lamps, such as tubular serpentine lamps. Unlike conventional fluorescent lamp arrays, custom-made serpentine lamps commonly provide good color characteristics, high luminance uniformity, and long lamp life. These lamps are typically hand made, and consequently, are comparatively costly. Moreover, these lamps are extremely fragile and difficult to install. Additionally, to optimize the light output, conventional serpentine backlight systems include a diffuser and reflective cavity, adding further cost to the overall information source. Therefore, while custom-made tubular serpentine lamps may meet certain standards for the backlighting function, the high cost and fragility detract from the advantages they offer.

5 A third alternative for backlighting information sources is flat fluorescent lamps. An exemplary flat fluorescent lamp described in U.S. Pat. No. 5,343,116, issued Aug. 30, 1994, to Winsor, comprises a substrate fritted to a transparent cover lid, forming an enclosure. Diffuse channels are formed into the substrate in the interior of the enclosure. Standard phosphors are added to the interior of the enclosure which is further flushed with a material for emitting energy, such as argon or mercury. Energy is emitted in the form of visible light when an electric potential is introduced to the lamp by two electrodes, with one electrode placed at each end of the diffuse channel. Plasma or other emissive material is ignited through sparking caused by the electric potential between the two electrodes. Such lamps offer ruggedness and lower manufacturing costs than serpentine tubular lamp alternatives.

10 However, the serpentine channel in these flat lamps is difficult to use in its optimal configuration. To achieve the desired light output without putting undue thermal stress on the lamp, the channel needs to be reduced in width and depth. As the surface area of the lamp must remain constant, the length of the channel needs to be increased to compensate for the reduction in width and depth.

15 This increased channel length requires a significantly higher voltage to achieve lamp ignition. When the electrodes spark the emissive material, it creates an arc that travels in one direction and has one ignition segment. The longer the diffuse channel, the longer the arc has to travel, and consequently, the greater the voltage that is needed to start the lamp. Due to the large voltage required to start conventional serpentine flat fluorescent lamps, the electronics that are required to perform that function can be costly, especially in applications having little space to spare for physically large power sources.

SUMMARY OF THE INVENTION

25 A lamp according to various aspects of the present invention comprises a channel having multiple channel segments and multiple electrodes. An enclosure that has an interior portion contains a fluorescent material and a material for emitting energy in response to an electric potential. The channel segments may be formed in any suitable manner, such as by adding at least one additional electrode at some point in the channel to define smaller conjoined channel

segments, such that multiple channel segments share at least one common electrode. In another embodiment, the lamp includes multiple channel segments configured so that the arc has at least two directions to travel, which may be implemented by creating parallel channel segments sharing at least two common electrodes.

5

BRIEF DESCRIPTION OF THE DRAWINGS

The subject matter of the invention is particularly pointed out and distinctly claimed in the concluding portion of the specification. The invention, however, both as to organization and method of operation, may best be understood by reference to the following description taken in conjunction with the claims and the accompanying drawings, in which like parts may be referred to by like numerals:

10

FIGURE 1 is a plan view of a flat fluorescent lamp in accordance with the present invention;

FIGURE 2 is a cross-sectional view of a flat fluorescent lamp in accordance with the present invention;

FIGURE 3 is a rear view of a flat fluorescent lamp in accordance with a preferred exemplary embodiment of the present invention;

FIGURE 4 is top plan view of a flat fluorescent lamp in accordance with the present invention having flares at the end of the channel walls;

FIGURES 5-8 are top plan views of further examples of flat fluorescent lamps in accordance with the present invention having conjoined ignition segment configurations,

FIGURES 9-12 are top plan views of examples of flat fluorescent lamps in accordance with the present invention having parallel ignition segment configurations;

FIGURES 13 and 14 are top plan views of flat fluorescent lamps in accordance with the present invention having combined conjoined/parallel configurations.

25

DETAILED DESCRIPTION OF THE PREFERRED EXEMPLARY EMBODIMENTS

The ensuing descriptions are preferred exemplary embodiments only, and are not intended to limit the scope, applicability, or configuration of the invention in any way. Rather,

the ensuing descriptions provide a convenient description for implementing a preferred embodiment of the invention, it being understood that various changes may be made in the function and arrangement of elements described in the preferred embodiments without departing from the spirit and scope of the invention as set forth in the appended claims.

5 Referring now to Figures 1 and 2, a flat fluorescent lamp 100 according to various aspects of the present invention includes a substrate 102, a cover lid 214, and a set of electrodes 218, 220, 224, 226. The substrate 102 comprises any suitable base for cooperating with the cover lid 214 to form an enclosure. In the present embodiment, the substrate 102 suitably includes two sidewalls 104 and 106 and two end walls 108 and 110 forming a rectangular perimeter. The substrate 102 may conform, however, to any appropriate shape based on relevant criteria, such as the shape of the display, space limitations, and the like. Substrate 102 is formed of any suitable material that is, preferably, rigid and self-supporting, such as glass or ceramic. A diffuse channel 116 is suitably formed by extending at least one channel wall 112 from the bottom of substrate 102 to substantially meet cover lid 214. The diffuse channel may be formed by milling, molding, or any other appropriate method. In the present embodiment, channel walls 112 extend in one direction and then alternate to the other direction so that a continuous channel is formed within substrate 102 from one corner to another. The channel walls 112 may be constructed, however, in any manner to create a diffuse channel having a suitable configuration in the lamp 100.

10
15
20
25 Diffuse channel 116 may have a variety of cross-sectional configurations which may optionally be altered for different applications. Conventional flat fluorescent lamps have a "U-like" cross-sectional shape, as seen in Figure 2, where the upper portions of the channel walls are straight or taper outward so that the top of the channel is wider than the bottom of the channel. However, the channel walls may also be constructed so that the walls taper inward, which results in the selective angular tuning of emitted light into a more intense cone of viewable light without requiring a greater power input. Additionally, the channels may optionally be milled so that they are either symmetrical or asymmetrical in cross-sectional shape. Generally, the cross-sectional shape may be altered depending upon the backlighting application for which the lamp is being employed.

As seen in Figures 1 and 2, the lid 214 is suitably attached, for example, by fritting the lid 214 to substrate 102 such that the lid 214 and the top portion of sidewalls 104 and 106, end walls 108 and 110, and channel walls 112 form an enclosure within lamp 100. The enclosure suitably includes a seal to maintain near-vacuum conditions inside the lamp 100. The lid 214 is preferably constructed of a substantially transparent or translucent material, preferably having a coefficient of thermal expansion that substantially matches that of substrate 102. In the present embodiment, the lid 214 suitably comprises glass.

At least a portion of the enclosure interior is coated with a material through painting, spraying, or any other appropriate technique. The applied material fluoresces in the visible spectrum under selected circumstances, such as when bombarded with ultraviolet radiation. In the present embodiment, the fluorescent material may be a phosphor, and more particularly, a rare earth phosphor. The interior portion of the lid 214 may also optionally be at least partially covered with the fluorescent material. In the present embodiment, the area of the lid 214 that substantially meets the tops of the channel walls is not coated with the fluorescent material. An activation material, such as an ultraviolet emissive material like a plasma, mercury, or argon, or another suitable activation material for selectably causing the fluorescent material to fluoresce, is placed in the enclosure.

The electrodes such as the electrodes 218, 220, 224, 226, spark the emissive material. The electrodes 218 220, 224, 226 may be configured in any appropriate manner to effectively activate the activation material and/or the fluorescent material. The electrodes may be disposed in a housing. The housing is suitably configured to physically and electrically isolate the electrode from the lamp exterior and place the electrode in electrical contact with the activation material and/or the fluorescent material. The housing may be further configured to optimize the light provided. For example, the housing may be configured as described in U.S. Pat. No. 5,818,164, issued Oct. 6, 1998, to Winsor.

In the present embodiment, housing suitably houses at least one electrode, such as a filament wire (not shown), with each electrode extending into lamp 200 for exciting the activation material and/or the fluorescent material. The housings are suitably located on the bottom exterior of the substrate 202. The housings suitably comprise glass bodies containing the

filaments and affixed to the lamp body, such as with a glass frit. The glass frit suitably exhibits a lower melting point than that of the housing. The attachment of the housings 118, 120, 122, which are suitably soldered to the bottom exterior of substrate 102 with the filament wires in place, can have a variety of configurations as to their location and attachment. The lamp 300
5 suitably includes multiple electrodes, each disposed within a housing, for sparking the lamp. The electrodes may comprise any appropriate electrode for sparking the activation material and/or the fluorescent material. Further, the electrodes may be powered by AC or DC power, by one or multiple power sources, at a variety of frequencies or amplitudes, as well as any other appropriate method.

10 Figure 3 illustrates a rear view of the flat fluorescent lamp 300 having multiple electrodes 304, 306, 308, 310, and 312. This configuration of electrodes is merely illustrative of one configuration according to various aspects of the present invention; any number of additional electrodes or reconfiguration of the electrodes may be provided. Additionally, the lamp may optionally also have a network of heating strips 314 affixed to the rear of the lamp. These heating strips assist in heating the flat fluorescent lamp, as well as providing a ground plane or start strip for the lamp. A metal covering (not shown) may also optionally be placed around the base of the flat fluorescent lamp to act as a heat sink.

6632134450
25 A flat lamp according to various aspects of the present invention includes a channel 116 partitioned into multiple channel segments by multiple electrodes. Each of the multiple channel segments is shorter than the total length of the channel 116. Each channel segment comprises at least a portion of the channel 116 and is defined by at least two ends. The channel segments are further defined by at least two electrodes, suitably placed at each end of the channel segments. Each electrode for a particular segment electrically connects to a different voltage potential to create a voltage difference across the length of the segment between the electrodes. For example, in a DC configuration, one electrode may be connected to a voltage source and the other electrode may be connected to ground. In an AC configuration, the electrodes are supplied with varying voltages. Because each segment is shorter than the total length of the channel 116, the applied voltage required to activate the activation material and/or the fluorescent material within the segment is less than the voltage required to spark the entire length of the channel 116.

A flat fluorescent lamp according to various aspects of the present invention, shown in Figure 4, includes a partitioned channel 116 having at least two channel segments 116A, 116B. Each channel segment is suitably approximately equal in length. In this embodiment, channel walls 408 are optionally flared at the ends to assist in optimizing light uniformity. Three electrodes 402, 404, and 406 define the two conjoined channel segments 116A, B. The electrodes 402, 404, 406 are positioned at the ends 450, 452, 454, 456 of the channel segments. In the present embodiment, the end 452 of the first channel segment 116A and the end 454 of the second channel segment 116B substantially coincide in a common electrode area 458. The two channel segments 116A, 116B share a common electrode 404 disposed in the common electrode area 458, which comprises the area surrounding the common electrode. The common electrode 404 suitably comprises any electrode which operates in conjunction with more than one channel segment.

In operation, the end electrodes 402, 406 are suitably connected to identical voltages, while the common electrode 404 is connected to a different voltage. Consequently, a substantially identical voltage potential forms from each end electrode 402, 406 across each channel segment 116A, B to common electrode 404. The electrodes 402, 404, 406 may be powered by the same source, or may be powered by different sources, or may be powered in any suitable manner. The two segments 116A, B spark at lower voltages than the voltages required to spark the full channel 116.

The channel 116 may be divided into channel segments in any suitable manner and configuration. Various electrode configurations facilitate limitless configurations for partitioning the channel 116. For example, Figures 5-8 show further exemplary embodiments of flat fluorescent lamps according to various aspects of the present invention having a series of suitably alternately charged electrodes to define channel segments. Figure 5 shows an embodiment wherein the lamp 500 has four electrodes of alternating positive and negative charge 502, 504, 506 and 508 on the same side of the lamp, forming three conjoined channel segments. The exemplary embodiment of Figure 6 has five electrodes of alternating positive and negative charge 602, 604, 608, 610, and 612 on alternating sides of the lamp 600. This creates four conjoined lamp segments. Figure 7 shows an exemplary embodiment of the present

invention having seven electrodes of alternating charge 702, 704, 706, 708, 710, 712, and 714, all on the same side of the lamp 700. The five extra electrodes 704, 706, 708, 710, and 712 create six conjoined channel segments. Figure 8 shows a further embodiment having thirteen electrodes of alternating charge 802, 804, 806, 808, 810, 812, 814, 816, 818, 820, 822, 824, and 826 on both sides of the lamp 800. This addition of electrodes 804-824 creates a lamp with 12 conjoined channel segments. Each of the above configurations creates channel segments that are significantly shorter than the length of the full channel, tending to facilitate lower starting voltages. The present invention is not limited to the embodiments described above; these embodiments are merely illustrative of the variety of configurations available.

In other embodiments, more than one electrode may be associated with multiple parallel segments by forming the serpentine channel to have more than one direction for the arc to travel. Exemplary embodiments of this type of configuration are shown in Figures 9-12. Additionally, parallel segments may be combined with series segments, such as the configurations illustrated in Figures 13 and 14.

Referring now to Figure 9, lamp 900 according to an exemplary embodiment has serpentine segments in a parallel configuration. The voltage potential applied by electrodes 902 and 904 propagates in two directions, such that the channel is divided into two segments. This configuration reduces the starting voltage of the lamp relative to conventional systems. By forming the diffuse channel with channel segments in a parallel configuration, two shorter ignition segments are formed without requiring the addition of any electrodes.

Similarly, as shown in Figure 10, an alternative lamp 1000 suitably includes four ignition segments in a diffuse channel 1006 formed so that the four serpentine segments are in a parallel configuration. When electrodes 1002 and 1004 charge, the arc travels through all four paths.

Figures 11 and 12 show two further exemplary lamps according to various aspects of the present invention. Lamp 1100 of Figure 11 has electrodes 1102, 1104, 1106, 1108, and 1110, which cause the arc to travel through the four parallel segments of diffuse channel 1112. Electrodes 1102, 1104, 1108, and 1110 are all suitably charged with a first voltage level, while electrode 1106 is suitably charged at a different level. For example, electrodes 1102, 1104, 1108, and 1110 may be negatively charged while electrode 1106 is positively charged. Lamp

1200 of Figure 12 similarly exhibits four parallel channel segments. Outer electrodes 1202, 1204, 1208, and 1210 are charged at a first voltage and inner electrode 1206 is charged at a second voltage. Diffuse channel 1212 may be formed with any number of segments and any appropriate number and configuration of electrodes.

5 Referring to Figures 13 and 14, an alternative lamp configuration suitably represents a hybrid of the series and parallel configurations. For example, lamp 1300 of Figure 13 has multiple, such as four, electrodes 1302, 1304, 1306, and 1308, which are charged at appropriate voltages to form potentials across the various segments. For example, two electrodes 1302, 1306 may be positively charged while two other electrodes 1304, 1308 are negatively charged. In this
10 configuration, channel 1310 comprises two sets of two conjoined channel segments in a parallel formation. Similarly, an alternative lamp 1400 of Figure 14 has alternating positive and negative electrodes 1402, 1404, and 1406, arranged in a channel 1408 comprising two conjoined sets of two parallel channel segments.

In all embodiments of the inventions, a reflective material, such as aluminum or ceramics, may further enhance the flat fluorescent lamp's perceived brightness. The reflective material may be applied in any suitable configuration. For example, referring to Figure 2, the reflective material 228 may be applied to the bottom exterior of substrate 202 to redirect light that would have been rear-emitted. Additionally, reflective material 228 may be placed in the interior of the lamp for redirecting light forward to be emitted as viewable light through cover lid
15 214. Reflective material 228 may be applied to the entire interior surface or may be applied to only a portion of the enclosure interior to yield a masking effect.

Additional materials may be included to enhance lamp performance. For example, a semi-transparent layer may also be applied to at least some portion of the interior of the enclosure to prevent ultraviolet emissive material migration into the fluorescent material or into
20 the matrix of substrate. The semi-transparent layer can be any suitable material, such as an aluminum oxide, which tends to extend the useful life of the lamp. Thus, additional materials for enhancing the lamp's brightness and life may be used for reducing the starting voltage, extending the life of the lamp, or achieving other design characteristics.

Thus, a flat fluorescent lamp according to various aspects of the present invention provides several features and advantages, such as a reduced starting voltage. In addition, the above descriptions are preferred exemplary embodiments only, and are not intended to be limiting in any way. Various modifications, substitutions, and other applications of the present
5 embodiments may be made without departing from the spirit and the scope of the invention as set forth in the appended claims.

66231 22460

CLAIMS

- 1 1. A lamp, comprising:
2 an enclosure having a channel defined therein, wherein said channel comprises a
3 plurality of channel segments, each of said channel segments having at least two ends;
4 and
5 a plurality of electrodes, wherein at least one electrode is positioned at each said
6 end of at least two of said channel segments/
2. A lamp according to claim 1, wherein said enclosure includes an interior wall
defining said channel.
3. A lamp according to claim 1, wherein a first end of a first channel segment and a
first end of a second channel segment are substantially coincident in a common electrode area,
and wherein a common electrode of said plurality of electrodes is positioned substantially within
said common electrode area.
4. A lamp according to claim 3, wherein:
 a second end of said first channel segment and a second end of said second
channel segment are substantially coincident in a second common electrode area; and
 a second common electrode of said plurality of electrodes is positioned
substantially within said second common electrode area.
5. A lamp according to claim 1, wherein at least a portion of said enclosure is coated
with a reflective material.
6. A lamp according to claim 5, wherein said reflective material comprises at least
one of aluminum and ceramic.

7. A lamp according to claim 1, wherein said enclosure contains a fluorescent material.

8. A lamp according to claim 7, wherein said fluorescent material is applied as a coating to at least a portion of an interior surface of said enclosure.

9. A lamp according to claim 1, wherein said enclosure includes a lid, and wherein said lid is at least partially coated with a fluorescent material.

10. A lamp according to claim 1, wherein said channel is serpentine.

11. A lamp according to claim 1, wherein the lamp is a flat lamp.

12. A lamp according to claim 1, wherein at least a portion of said channel has an asymmetrical cross-section.

13. A lamp, comprising:

an enclosure configured to contain a fluorescent material, including:

a base;

an exterior wall supported on said base;

an interior wall, wherein said interior wall and said exterior wall define a diffuse

channel comprising a plurality of channel segments; and

a plurality of electrodes, wherein said electrodes are disposed within said

enclosure at the ends of at least two of said channel segments.

14. A lamp according to claim 13, further comprising a lid positioned opposite said base and attached to said exterior wall.

0
1
2
3
4
5
6
7
8

15. A lamp according to claim 14, wherein said enclosure includes a lid, and wherein said lid is at least partially coated with a fluorescent material.

16. A lamp according to claim 13, wherein said enclosure further includes an interior wall defining said channel.

17. A lamp according to claim 13, wherein a first end of a first channel segment and a first end of a second channel segment are substantially coincident in a common electrode area, and wherein a common electrode of said plurality of electrodes is positioned substantially within said common electrode area.

1 18. A lamp according to claim 17, wherein:
2 a second end of said first channel segment and a second end of said second
3 channel segment are substantially coincident in a second common electrode area; and
4 second common electrode of said plurality of electrodes is positioned
5 substantially within said second common electrode area.

19. A lamp according to claim 13, wherein at least a portion of said enclosure is coated with a reflective material.

20. A lamp according to claim 19, wherein said reflective material comprises at least one of aluminum and ceramic.

21. A lamp according to claim 13, wherein said enclosure contains a fluorescent material.

22. A lamp according to claim 21, wherein said fluorescent material is applied as a coating to at least a portion of an interior surface of said enclosure.

23. A lamp according to claim 13, wherein said channel is serpentine.

24. A lamp according to claim 13, wherein the lamp is a flat lamp.

25. A lamp according to claim 13, wherein at least a portion of said channel has an asymmetrical cross-section.

1 26. A lamp, comprising:

2 an enclosure having an interior surface, wherein said interior surface is at least
3 partially coated with a fluorescent material, and wherein said interior surface defines a
4 diffuse channel having a plurality of channel segments, wherein at least two of said
5 channel segments share a common first end; and

6 a first common electrode positioned approximately at said first common end of
7 said at least two of said channel segments.

27. A lamp according to claim 26, wherein said at least two of said channel segments share a common second end, and further including a second common electrode positioned approximately at said second end of said at least two of said channel segments.

28. A lamp according to claim 26, wherein at least a portion of said interior surface is coated with a reflective material.

29. A lamp according to claim 28, wherein said reflective material comprises at least one of aluminum and ceramic.

30. A lamp according to claim 26, wherein said enclosure contains a fluorescent material.

31. A lamp according to claim 30, wherein said fluorescent material is applied as a coating to at least a portion of said interior surface.

32. A lamp according to claim 26, wherein said enclosure includes a lid, and wherein said lid is at least partially coated with a fluorescent material.

33. A lamp according to claim 26, wherein said channel is serpentine.

34. A lamp according to claim 26, wherein the lamp is a flat lamp.

35. A lamp according to claim 26, wherein at least a portion of said channel has an asymmetrical cross-section.

66002018 11/23/08 11:45:00 AM

PARTITIONED FLAT FLUORESCENT LAMP

Inventor: Alan S. Feldman

ABSTRACT

5 A lamp has an enclosure with partitions has channel segments and/or multiple directions for an electrical arc to travel. The channel segments can be implemented by adding additional electrodes in the a channel formed by the partitions, by forming a channel where the arc may travel in multiple directions, or by a combination of the methods. The channel segments and multiple directions of arc travel tend to reduce the voltage required to start the lamp.

682966.3

682966.3

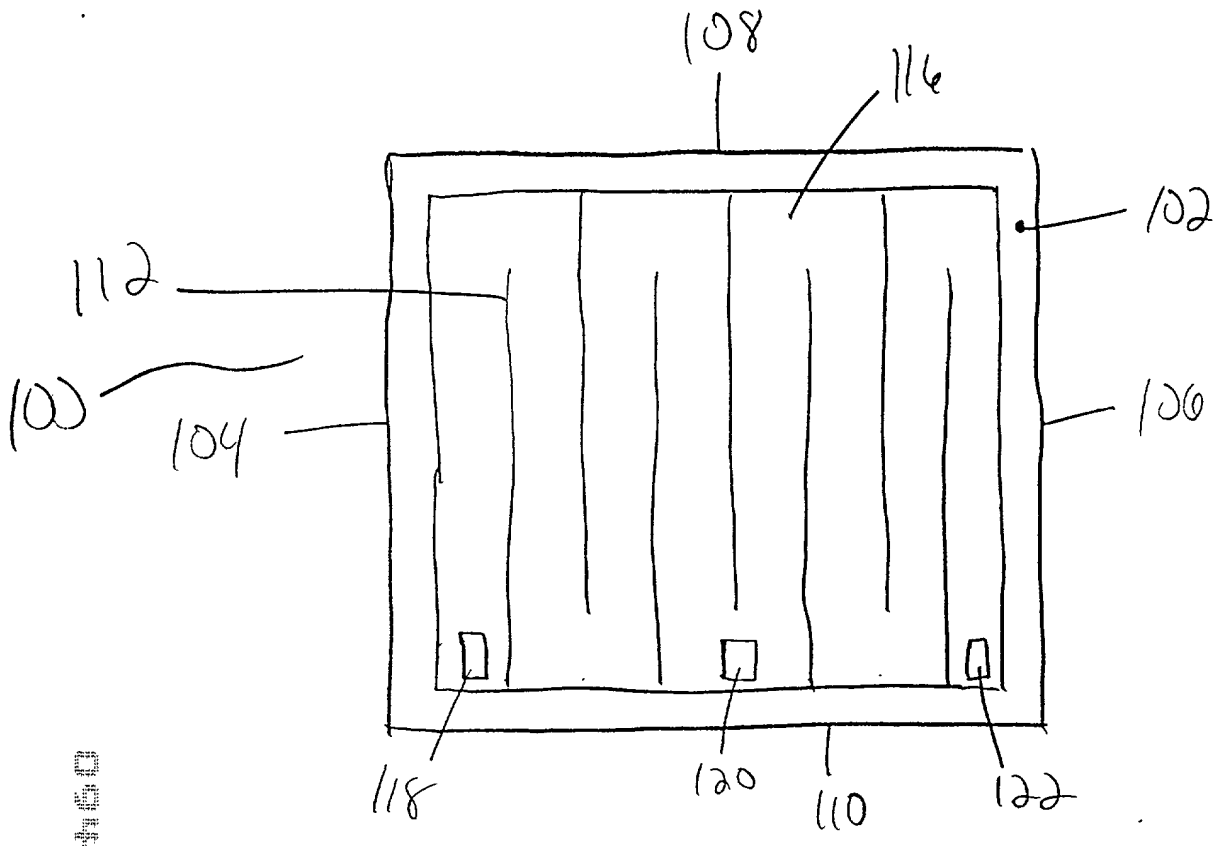

FIGURE 1

6622313-13299

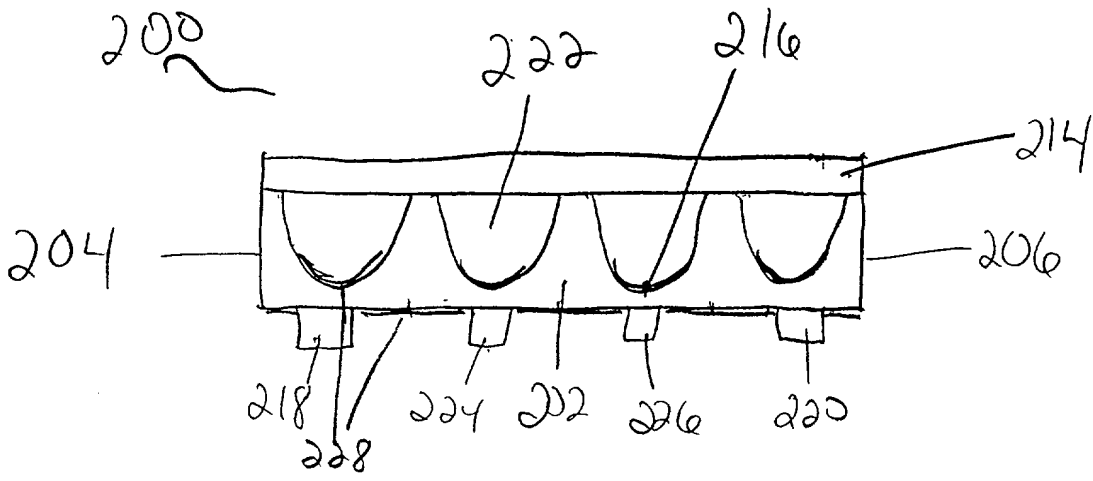

FIGURE 2

094276-1-2009

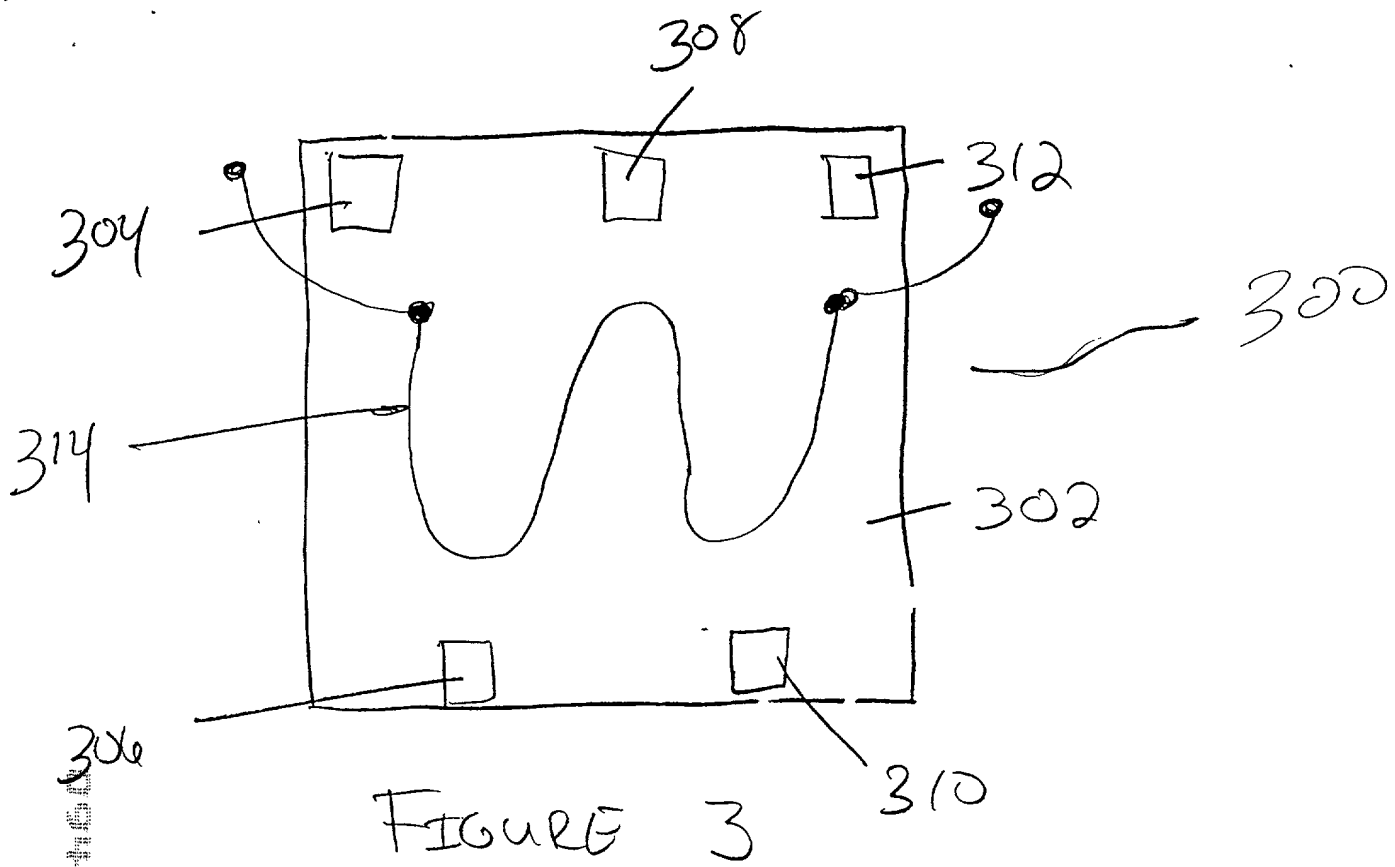

FIGURE 3

662246

663227 322450

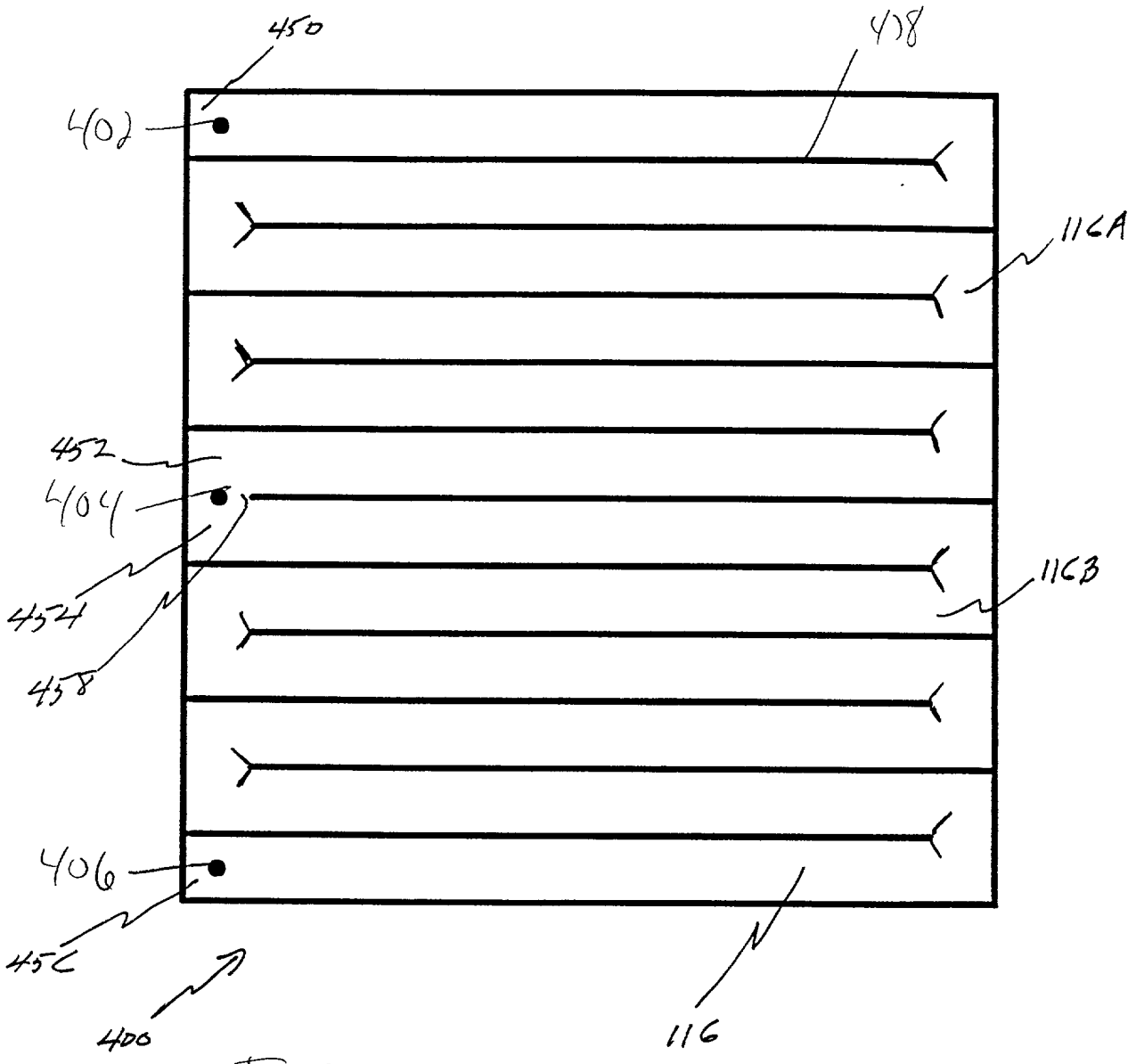
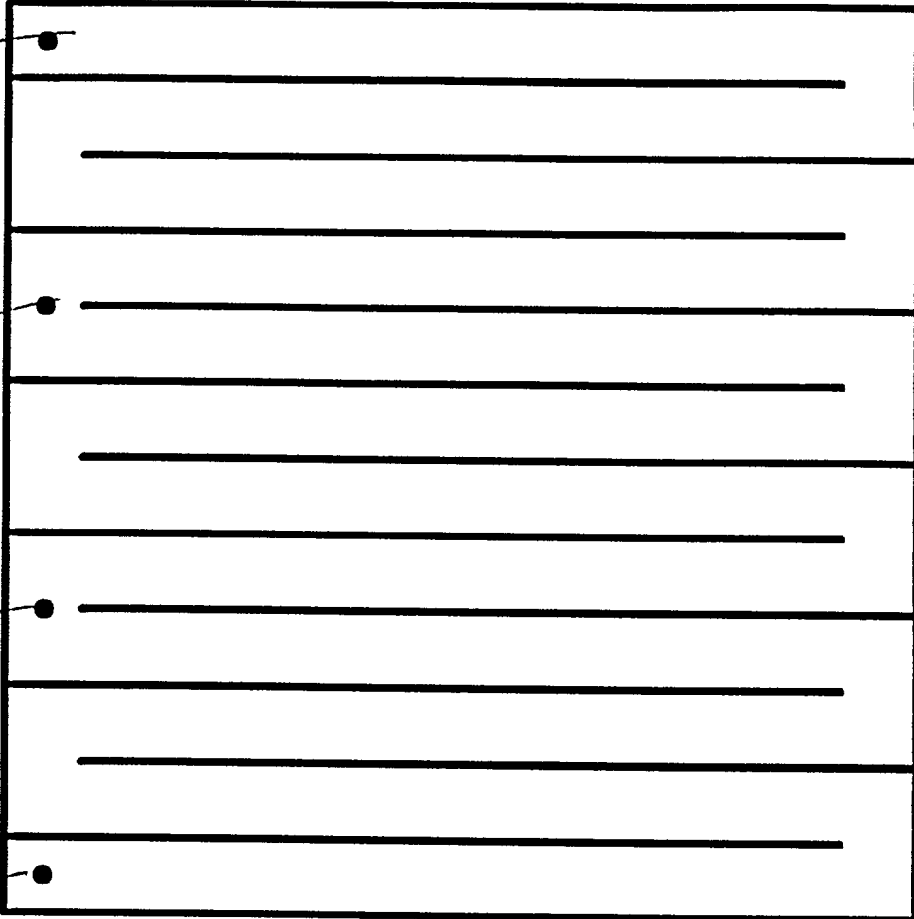

FIGURE 4

500



663221 242460

FIGURE 5

0947318-12399

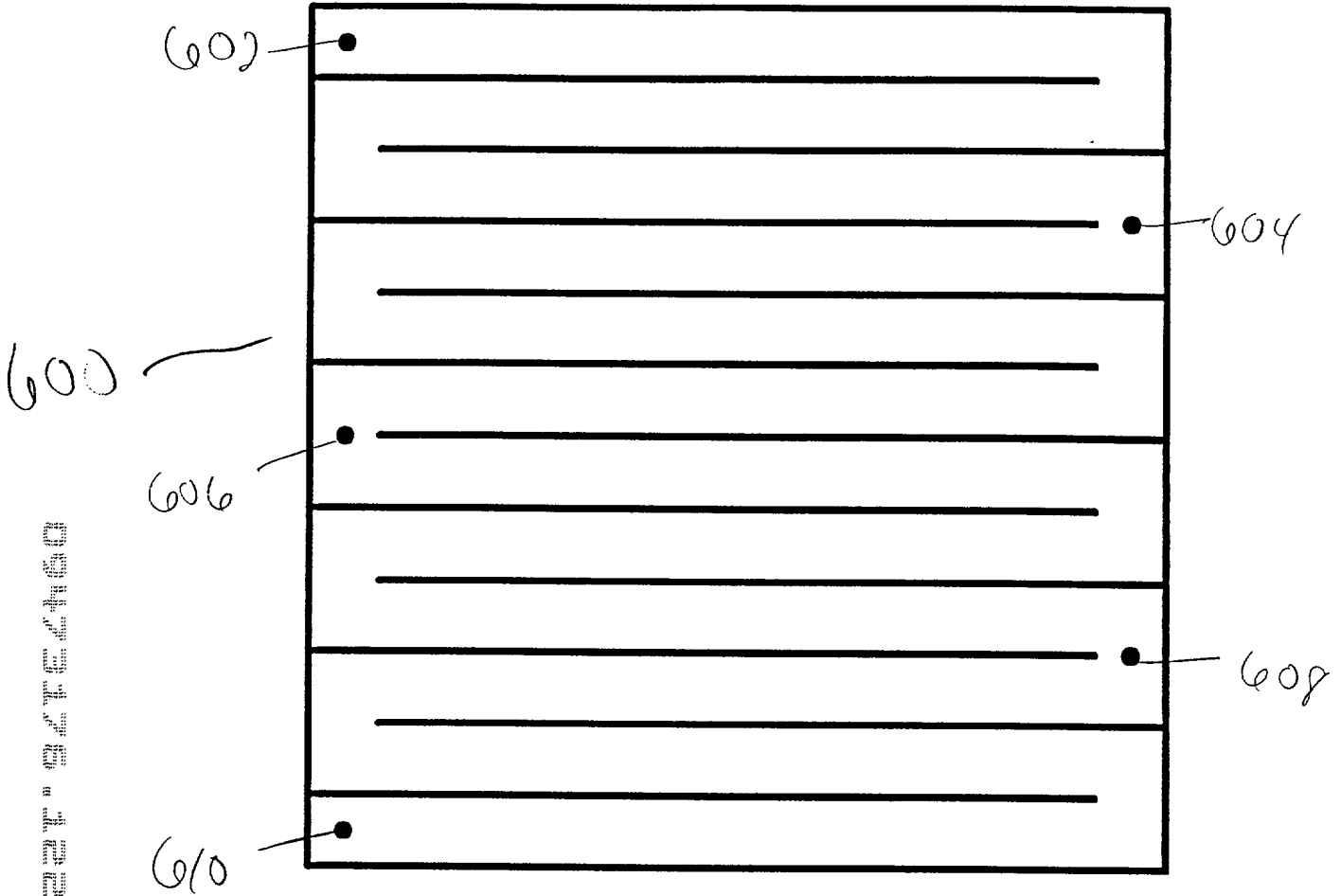

FIGURE 6

700

66887 572450

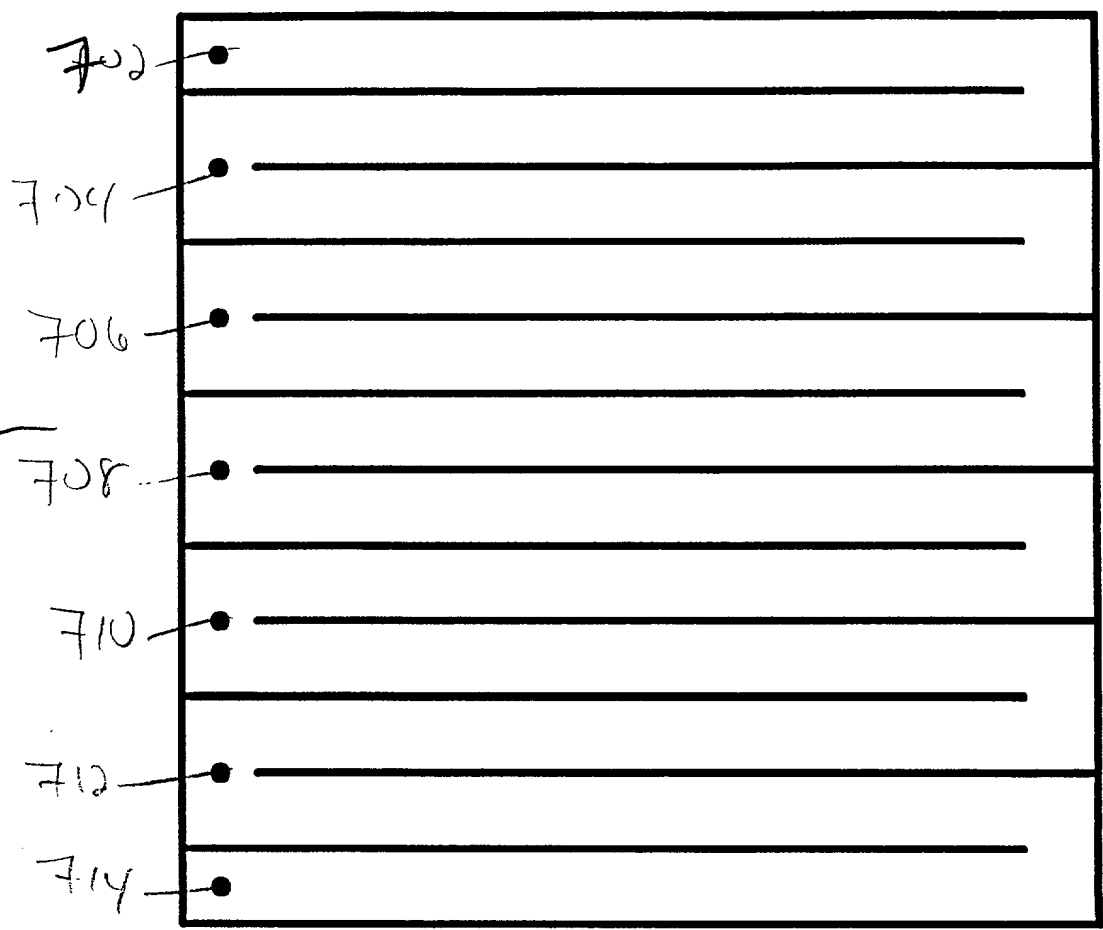

FIGURE 7

800

0947336-12899

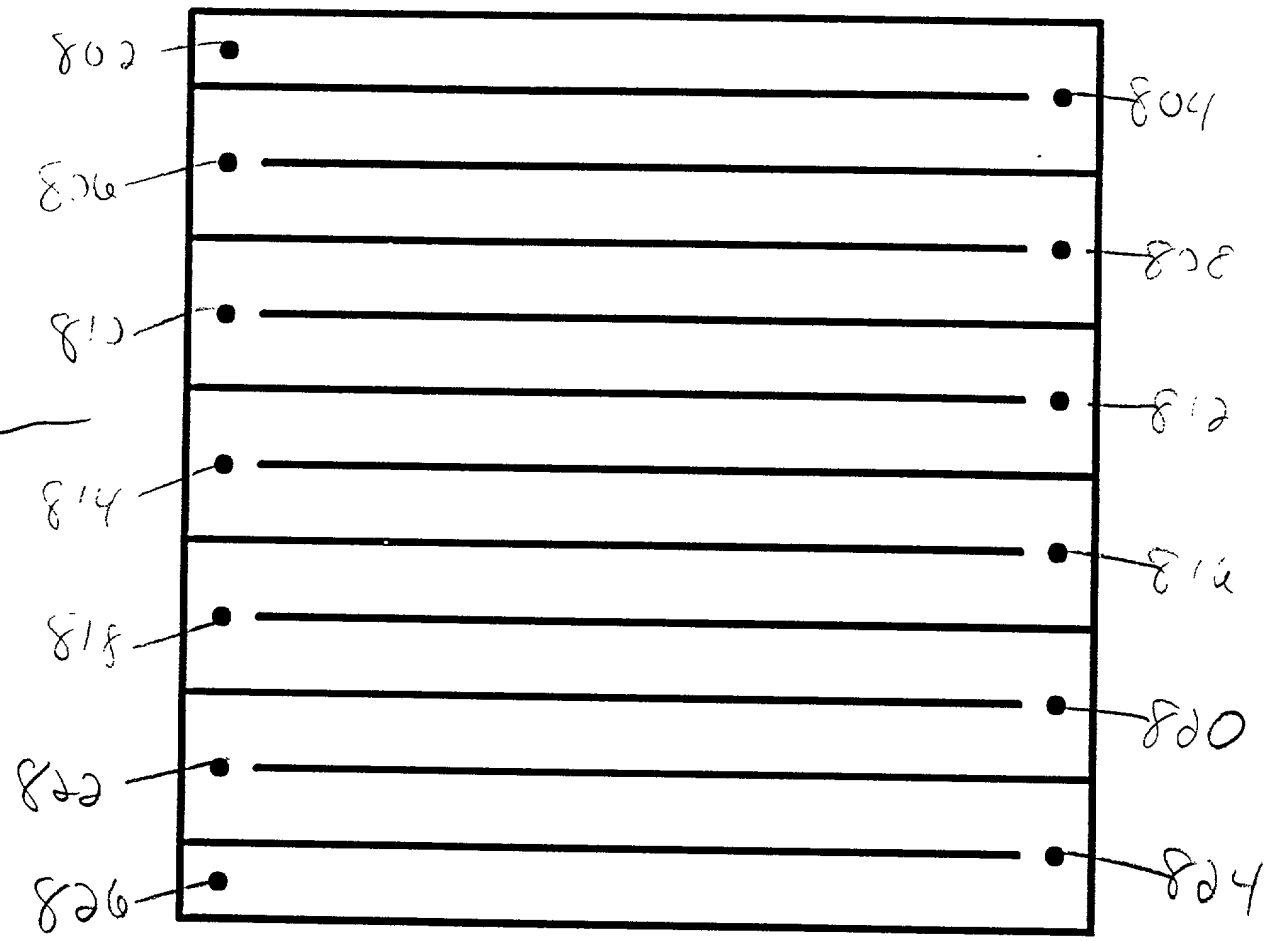

FIGURE 8

900

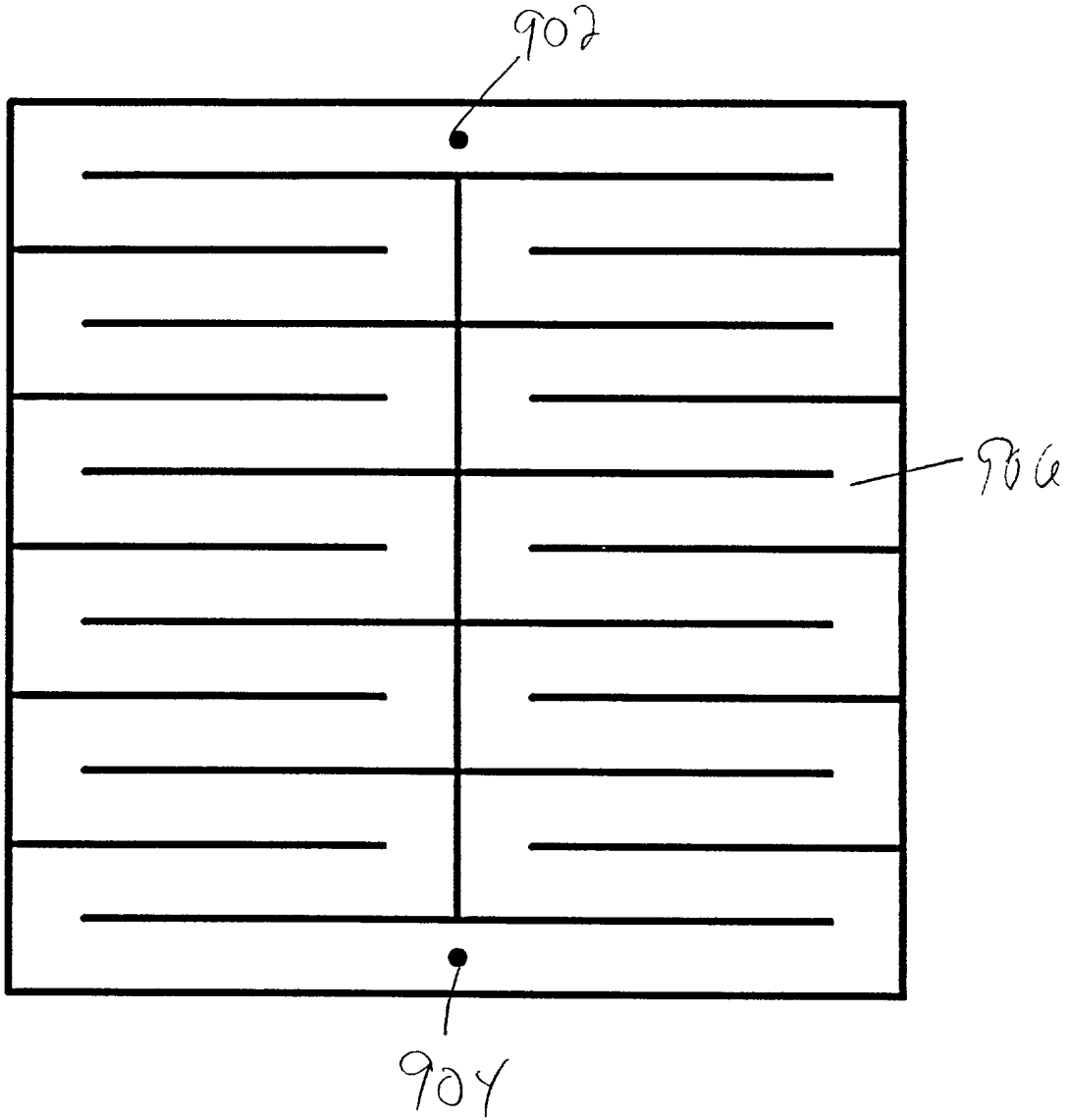

FIGURE 9

047317B-12899

1000

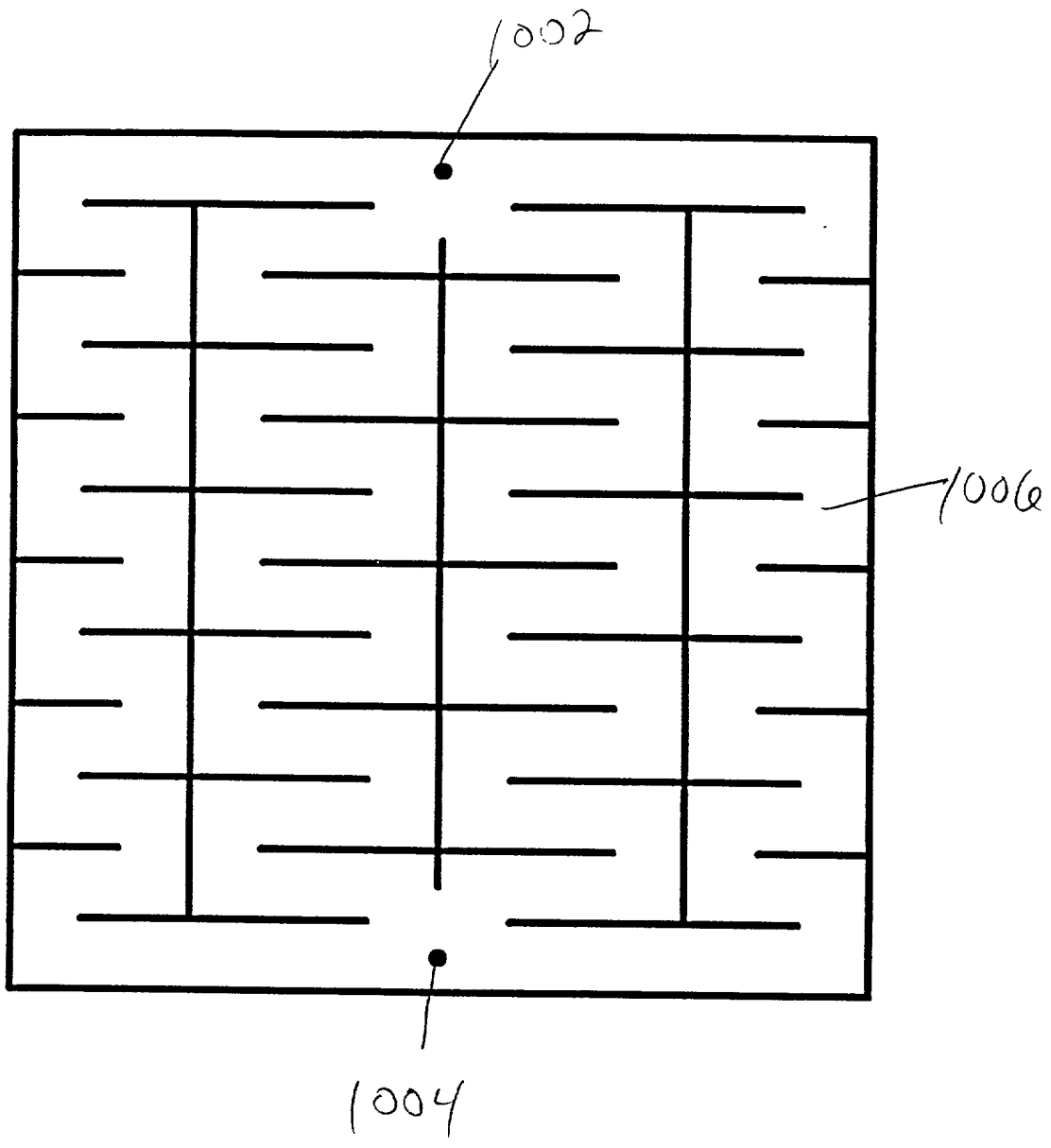

FIGURE 10

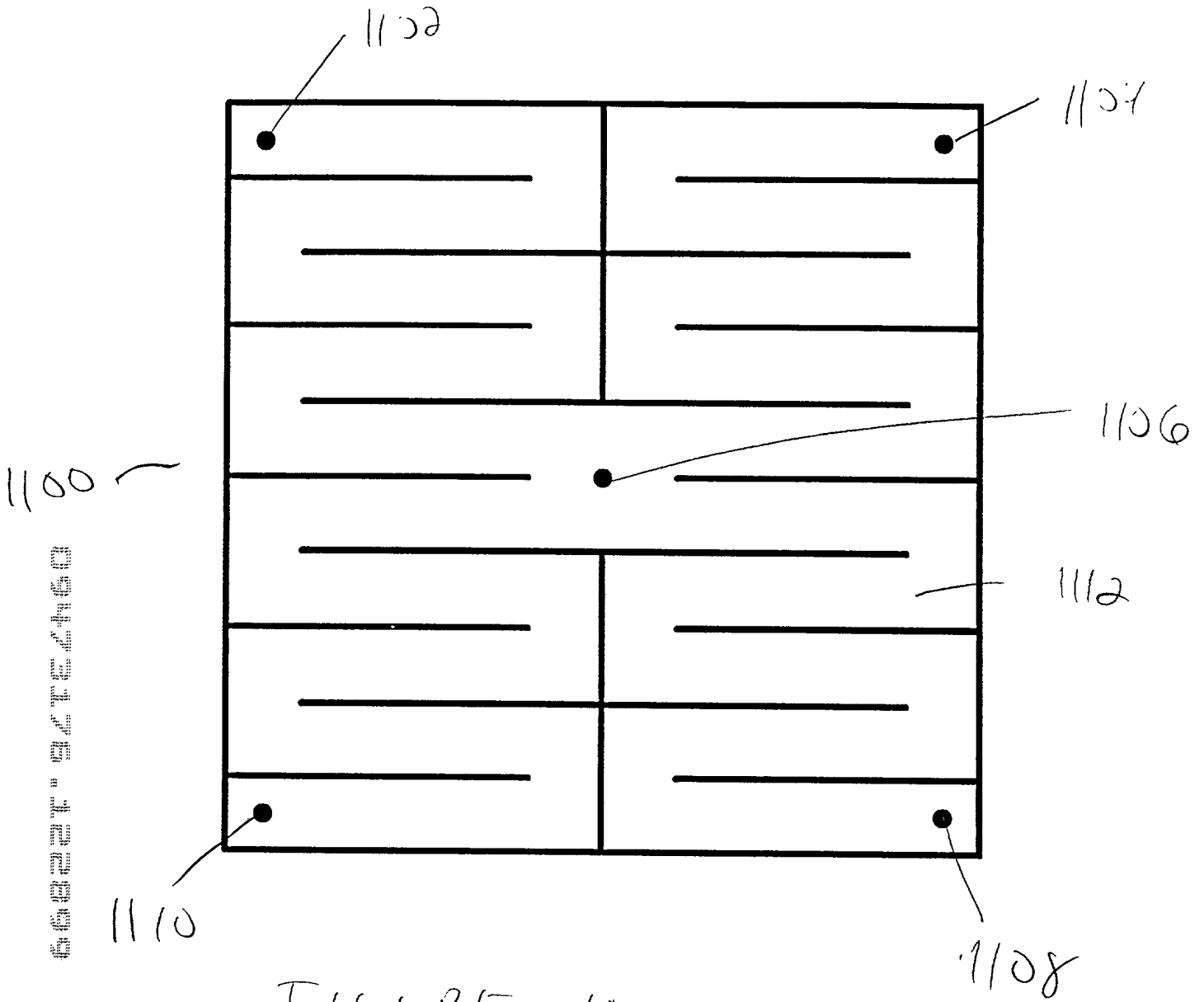

FIGURE 11

663221 92E450

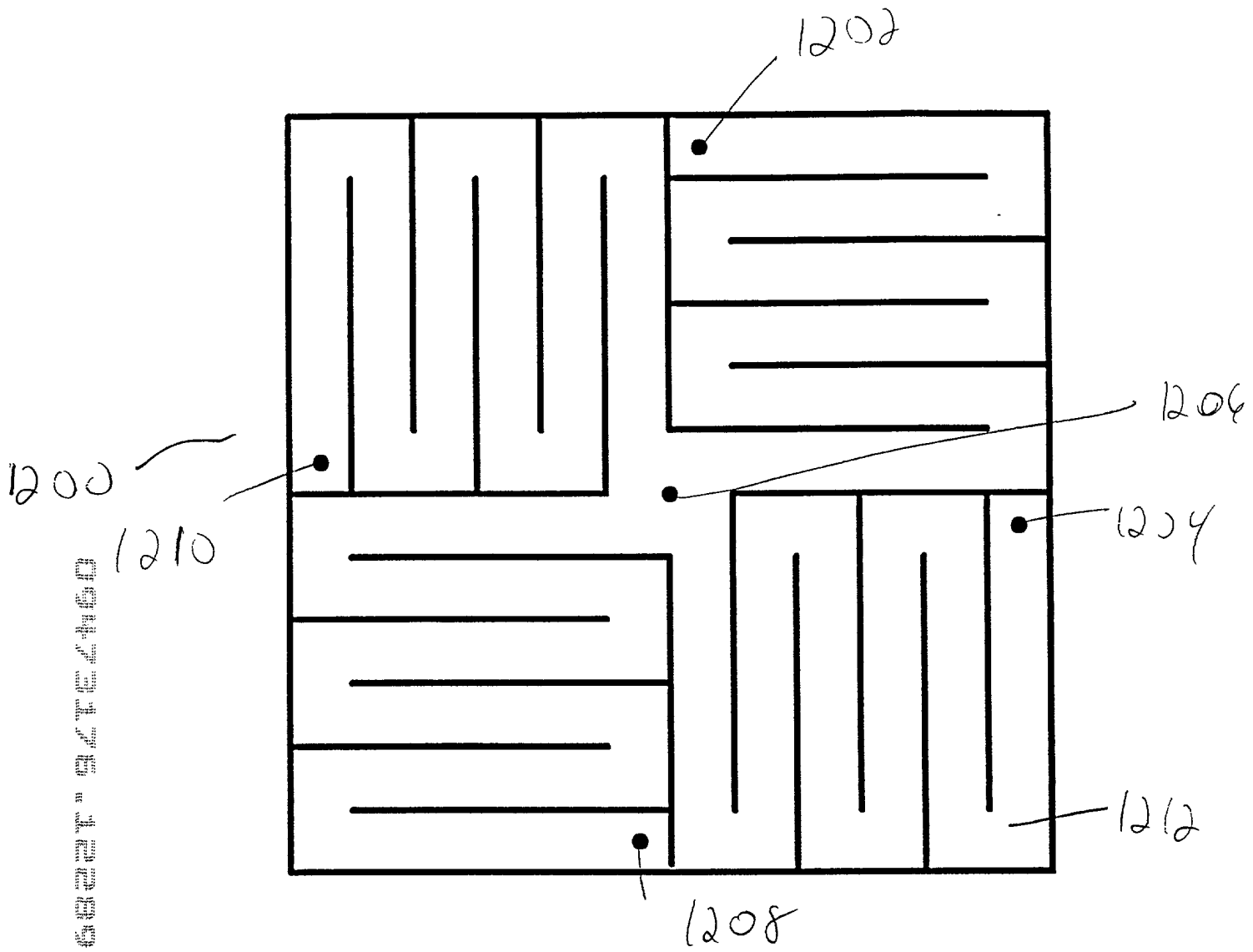
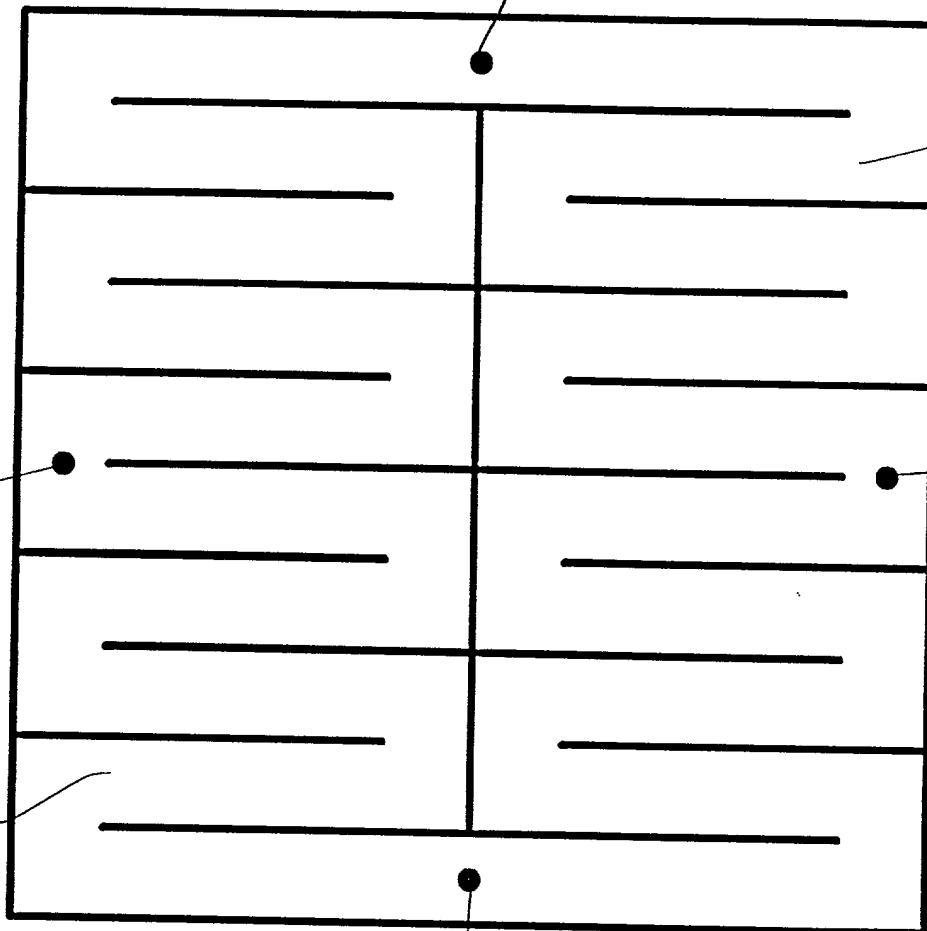

FIGURE 12.



1308
FIGURE 13

6624474

14
047317B.12299
0 ~

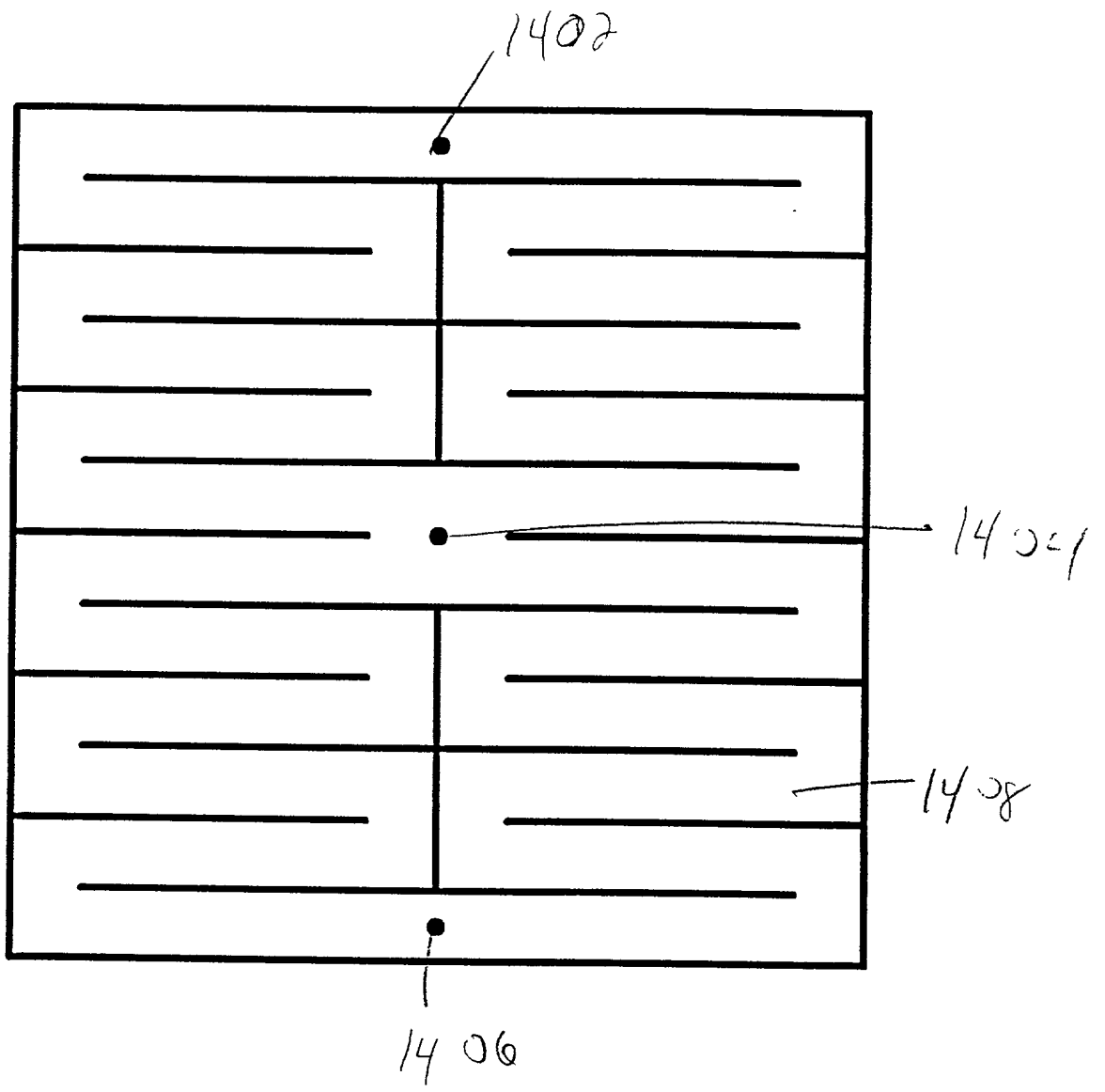

FIGURE 14

DECLARATION AND POWER OF ATTORNEY

As a below named inventor, I hereby declare that:

My residence, post office address and citizenship are as stated below next to my name;

I believe I am the original, first and sole inventor (if only one name is listed below) or an original, first and joint inventor (if plural names are listed below) of the subject matter which is claimed and for which a patent is sought on the invention entitled:

PARTITIONED FLAT FLUORESCENT LAMP

The specification of which

(check one)

X is attached hereto
_____ was filed on _____ as
Application Serial No. _____
and was amended on _____. (if applicable)

I hereby state that I have reviewed and understand the contents of the above-identified specification, including the claims, as amended by any amendment referred to above.

I acknowledge the duty to disclose information which is material to the examination of this application in accordance with Title 37, Code of Federal Regulations, §1.56(a).*

I hereby claim foreign priority benefits under Title 35, United States Code §119 of any foreign application(s) for patent or inventor's certificate listed below and have also identified below any foreign application for patent or inventor's certificate having a filing date before that of the application on which priority is claimed:

Prior Foreign Application(s) Priority Claimed

(Number)	(Country)	(Day/Month/Year Filed)	Yes	No

I hereby claim the benefit under Title 35, United States Code §120 of any United States application(s) listed below and, insofar as the subject matter of each of the claims of this application is not disclosed in the prior United States application in the manner provided by the first paragraph of Title 35, United States Code §112, I acknowledge the duty to disclose material information as defined in Title 37, Code of Federal Regulations §1.56(a) which occurred between the filing date of the prior application and the national or PCT international filing date of this application:

66337 24463

(Application Serial No.)

(Filing Date)

(Status)

(patented, pending,
abandoned)

I hereby appoint the following attorney(s) and/or agent(s) to prosecute this application and to transact all business in the Patent and Trademark Office connected therewith: JOHN G. SHUDY (Reg. No. 31,214), ALBERT K. KAU (Reg. No. 40,672), MICHAEL K. KELLY (Reg. No. 32,848), CHARLES F. HAUFF, JR. (Reg. No. 33,244), DANIEL J. NOBLITT (Reg. No. 35,969), JOHN A. FISHER (Reg. No. 28,505), LAURA J. ZEMAN (Reg. No. 36,078), MARK M. TAKAHASHI (Reg. No. 38,631), HOWARD I. SOBELMAN (Reg. No. 39,038), BRETT A. CARLSON (Reg. No. 39,928), DAVID O. CAPLAN (Reg. No. 41,655), R. LEE FRALEY (Reg. No. 42,550), KAREN L. HUNNICUTT (Reg. No. 42,677), CYNTHIA L. PILLOTE (Reg. No. 42,999), DANIEL R. POTE (Reg. No. 43,011), DAMON L. BOYD (Reg. No. 44,552), DEBORAH M. CHESS (Reg. No. 44,611). Address all telephone calls to DANIEL J. NOBLITT at telephone number (602) 382-6305.

Address all correspondence to Honeywell Inc., Honeywell Plaza, MN12-8251, P.O. Box 524, Minneapolis, Minnesota 55440 U.S.A.

I hereby declare that all statements made herein of my own knowledge are true and that all statements made on information and belief are believed to be true; and further that these statements were made with the knowledge that willful false statements and the like so made are punishable by fine or imprisonment, or both, under Section 1001 of Title 18 of the United States Code and that such willful false statements may jeopardize the validity of the application or any patent issued thereon.

Full Name of Sole
or First Inventor Alan S. Feldman

Inventor's Signature _____ Date _____, 19__

Residence _____

Citizenship _____

Post Office Address _____

Full Name of Second
Joint Inventor, If Any _____

Inventor's Signature _____ Date _____, 19__

Residence _____

Citizenship _____

Post Office Address _____

663227 227245

Full Name of Third
 Joint Inventor, If Any _____
 Inventor's Signature _____ Date _____, 19__
 Residence _____
 Citizenship _____
 Post Office Address _____

*Title 37, Code of Federal Regulations §1.56:

- (a) A patent by its very nature is affected with a public interest. The public interest is best served, and the most effective patent examination occurs when, at the time an application is being examined, the Office is aware of and evaluates the teachings of all information material to patentability. Each individual associated with the filing and prosecution of a patent application has a duty of candor and good faith in dealing with the Office, which includes a duty to disclose to the Office all information known to that individual to be material to patentability as defined in this section. The duty to disclose information exists with respect to each pending claim until the claim is canceled or withdrawn from consideration, or the application becomes abandoned. Information material to the patentability of a claim that is canceled or withdrawn from consideration need not be submitted if the information is not material to the patentability of any claim remaining under consideration in the application. There is no duty to submit information which is not material to the patentability of any existing claim. The duty to disclose all information known to be material to patentability is deemed to be satisfied if all information known to be material to patentability of any claim issued in a patent was cited by the Office or submitted to the Office in the manner prescribed by §§ 1.97(b)-(d) and 1.98. However, no patent will be granted on an application in connection with which fraud on the Office was practiced or attempted or the duty of disclosure was violated through bad faith or intentional misconduct. The Office encourages applicants to carefully examine:
- (1) Prior art cited in search reports of a foreign patent office in a counterpart application, and
 - (2) The closest information over which individuals associated with the filing or prosecution of a patent application believe any pending claim patentably defines, to make sure that any material information contained therein is disclosed to the Office.
- (b) Under this section, information is material to patentability when it is not cumulative to information already of record or being made of record in the application, and
- (1) It establishes, by itself or in combination with other information, a prima facie case of unpatentability of a claim; or
 - (2) It refutes, or is inconsistent with, a position the applicant takes in:
 - (i) Opposing an argument of unpatentability relied on by the Office, or
 - (ii) Asserting an argument of patentability.

A prima facie case of unpatentability is established when the information compels a conclusion that a claim is unpatentable under the preponderance of evidence, burden-

66221-927460

of-proof standard, giving each term in the claim its broadest reasonable construction consistent with the specification, and before any consideration is given to evidence which may be submitted in an attempt to establish a contrary conclusion of patentability.

- (c) Individuals associated with the filing or prosecution of a patent application within the meaning of this section are:
 - (1) Each inventor named in the application;
 - (2) Each attorney or agent who prepares or prosecutes the application; and
 - (3) Every other person who is substantively involved in the preparation or prosecution of the application and who is associated with the inventor, with the assignee or with anyone to whom there is an obligation to assign the application.
- (d) Individuals other than the attorney, agent or inventor may comply with this section by disclosing information to the attorney, agent, or inventor.

767010 1

0547234 12299